

Low Profile

Galvanized

Wheel Nose

# Specialty Pallet Trucks

Stainless Steel

Chrome & Zinc Plated

Pallet Truck with Scale



**Front Row: Galvanized, Wheel Nose, Chrome, Pallet Jack with Scale**  
**Back Row: Big Wheel, Stainless Steel, Standard, Stainless Steel Forks**

## Pallet Trucks for Corrosive & Sanitary Environments

### **GALVANIZED, ZINC AND CHROME PLATED**

Designed for corrosive or wet environments these full featured pallet trucks were designed for chemical, pharmaceutical and washdown applications.

### **STAINLESS STEEL AND STAINLESS STEEL FRAME & FORKS**

Ideal for sanitary, pharmaceutical, medical, food and wet environments. Choose either 304 stainless steel frame and forks or entirely 304 stainless steel pallet truck for long life in even the most harsh environments.

### **Application Environments**

- Laboratory
- Clean Room
- Wash Down
- Corrosive Material Handling

### **Features**

- Adjustable Solid Push Rods
- 180° Turning Radius

### **Options**

- Skid Adaptor
- Low Temperature Hydraulic Oil

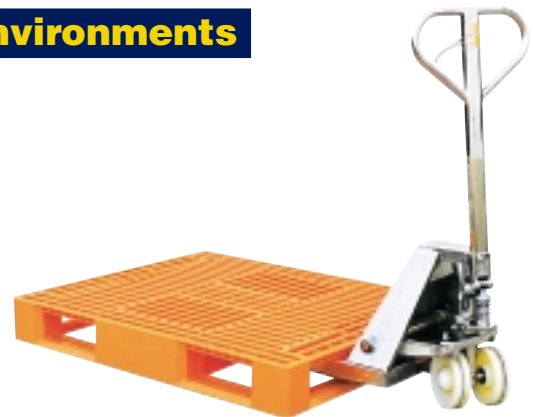

MODEL NUMBER	DESCRIPTION	CAPACITY (POUNDS)	OVERALL FORK DIMENSIONS	SERVICE RANGE	BETWEEN FORKS
PM5-2748-CP	CHROME PLATED	5,500	27"W x 48"L	2-7/8" - 7-3/4"	13"
PM5-2748-S-G	GALVANIZED	5,500	27"W x 48"L	2-7/8" - 7-3/4"	13"
PM5-2748-S-Z	ZINC COATED	5,500	27"W x 48"L	2-7/8" - 7-3/4"	13"
PM5-2748-SS	304 STAINLESS STEEL	5,500	27"W x 48"L	2-7/8" - 7-3/4"	13"
PM5-2748-SFF	304 STAINLESS FRAME & FORKS	5,500	27"W x 48"L	2-7/8" - 7-3/4"	13"

## Low Profile Pallet Truck

**Low Profile Pallet Truck** enters pallets from all four sides. All steel frame is reinforced to handle 4,000 lb. capacity loads. Wide loop control handle with lift, neutral, and lower functions provides fingertip control. Lifetime lubricated bearings. Hydraulic system has hard chrome plated pump piston with polyurethane seals. Suspension system has heavy-duty thrust bearing. Complete with adjustable push rods, polyurethane wheels, steel load rollers and red powder coated finish.

MODEL NUMBER	CAPACITY (POUNDS)	OVERALL FORK DIMENSIONS	SERVICE RANGE	BETWEEN FORKS
PM4-2048-LP	4,000	20"W x 48"L	1-7/8" - 6-1/4"	6"
PM4-2748-LP	4,000	27"W x 48"L	1-7/8" - 6-1/4"	13"
PM4-3348-LP	4,000	33"W x 48"L	1-7/8" - 6-1/4"	19"

Side entry 27" wide for use with 42" long pallets. 33" wide for use with 48" long pallets

Rubber Grip Handle

**LOW PROFILE DESIGN ONLY**  
**1-7/8" OFF THE GROUND**



## Wheel Nose Pallet Truck

The **Wheel Nose Pallet Truck** is designed to position pallets or skids closely in a row. The fork end is set back from the front rollers allowing for one pallet pick up at a time. The unit has a rubber grip handle with a three lever position for easy operation and maneuvering. This heavy-duty unit is rated at 5,000 pounds capacity and has a service range from 3-1/2" to 8". Unit includes two articulating steering wheels and two front load rollers. Spring loaded loop handle automatically returns to vertical position when not in use. Extra long 54" forks are used with standard 48" long pallets. Short 38" forks are used for maneuvering in tight spaces.

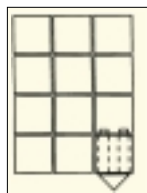

Wheel Nose Pallet Truck

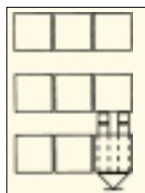

Standard Pallet Truck

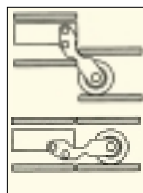

Positions Closely

MODEL NUMBER	CAPACITY (POUNDS)	OVERALL FORK DIMENSIONS	SERVICE RANGE	BETWEEN FORKS
PM5-2038-WN	5,000	20"W x 38"L	3-1/2" - 8"	7"
PM5-2738-WN	5,000	27"W x 38"L	3-1/2" - 8"	14"
PM5-2054-WN	5,000	20"W x 54"L	3-1/2" - 8"	7"
PM5-2754-WN	5,000	27"W x 54"L	3-1/2" - 8"	14"

For usable fork length without the rollers subtract 2"

**Take the guess work out of close pallet placement.**

**OPTIMIZE FLOOR AND TRUCK SPACE WITH THIS INNOVATIVE PALLET TRUCK**



## Pallet Truck with Scale

The **Pallet Truck with Scale** allows you to weigh your load on the spot for maximum efficiency. The frame uses heavy-duty steel construction for maximum strength and durability. This model is very user friendly and is suitable for low height lifting. The built in scale allows you to weigh your load as you are handling it. The scale is selectable in a variety of increments to adjust to the size of your load. It has keyboard calibration and functional setup with automatic zero capabilities. The digital filtering is used to help compensate for vibration and motion to make the Pallet Truck with Scale smooth and accurate.

MODEL NUMBER	CAPACITY (POUNDS)	OVERALL FORK DIMENSIONS	SERVICE RANGE	BETWEEN FORKS
PM-SCALE	4,000	28"W x 45"L	3-3/4" x 8"	14"



**WEIGH YOUR PACKAGES PRIOR TO LOADING/UNLOADING**



**Moves Loads:**

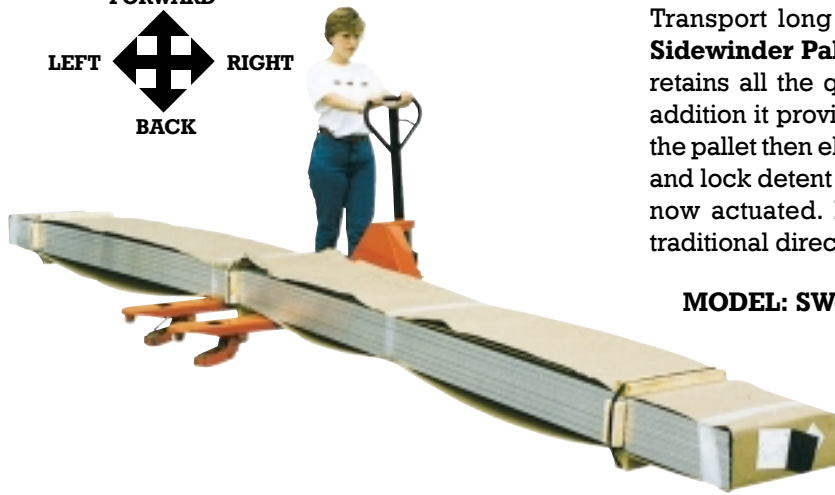
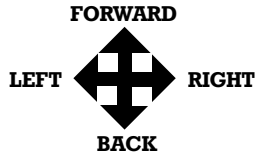

**Sidewinder Pallet Truck**

Transport long loads down narrow aisles with this heavy duty **Sidewinder Pallet Truck**. This versatile Side Winder Pallet Truck retains all the quality workmanship of a standard pallet truck, in addition it provides lateral movement. Simply place the forks into the pallet then elevate to approximately seven inches, rotate handle and lock detent into place. The second set of rollers, right/left, are now actuated. Now push the Sidewinder perpendicular to the traditional direction. Capacity is 3,000 lb.

**MODEL: SW-PJ**

**Move Long Loads Down Narrow Aisles**

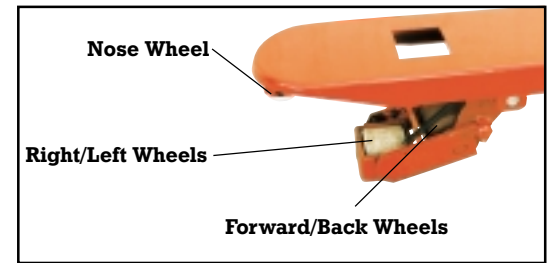
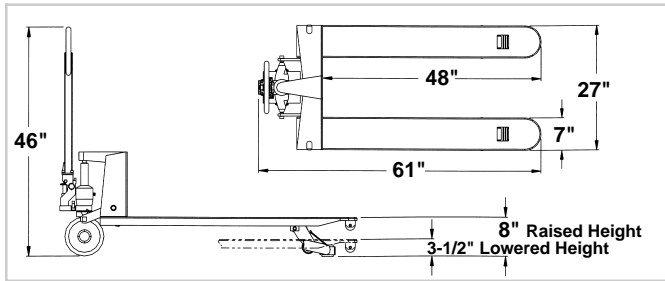

**MODEL: BW-PJ**

STEERING WHEEL: 8" x 2"  
LOAD ROLLERS: 5-1/2" x 2"

Use less pushing or pulling force when transporting large heavy loads across floors with the **Big Wheel Pallet Truck**. An alternative to fork trucks, this unit makes it easier to move loaded tubs weighing up to 4,500 pounds. The raised height of 16-1/8", lowered height 6-1/2" enables the pallet truck to service high bottom tubs. The Big Wheel Pallet Truck retains all of the quality workmanship of our Pallet Master Pallet Truck.

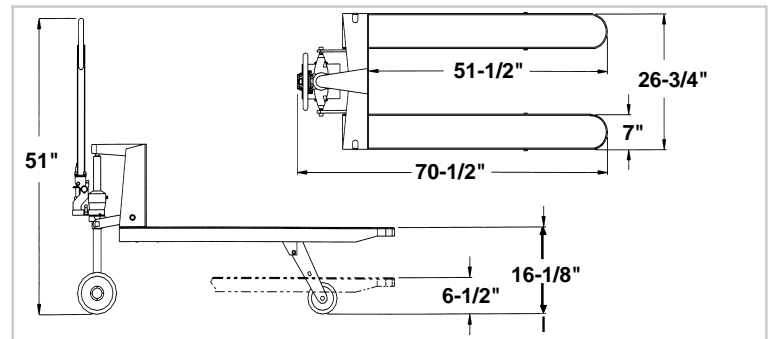

**SPRING PIN HOLDS ADAPTER IN VERTICAL POSITION FOR NORMAL PALLET TRUCK USE.**

**Skid Adaptor for Pallet Trucks**

Increase the raised height by 3" to handle skids with the **Skid Adaptor**. Adapts to most pallet trucks with an overall fork width of either 20" or 27" and a minimum fork length of 48". Skid adaptor may be rotated into vertical position for normal pallet truck use.

MODEL NUMBER	OVERALL FORK DIMENSIONS	INCREASED RAISED HEIGHT
PM5-20SA	20"W x 48"L	3"
PM5-27SA	27"W x 48"L	3"

## Ergonomic Pallet Truck with Start-Up Assist

### STANDARD FEATURES

- Start-up Assist Traction Drive
- Shock Absorbing Polyurethane Wheels
- Solid Steel Adjustable Push Rod
- Foot and Hand Lever Release

Anyone who has operated a fully loaded pallet truck knows the most strenuous part is getting the wheels rolling. This Pallet Truck solves this back breaking problem.

Pumping the handle of the pallet truck serves two purposes; first, it serves the traditional purpose of lifting the forks, second switch, to the power drive accumulator and by pulling the handle back the pallet truck begins to roll automatically. Each full stroke provides over 2 feet of power driving momentum.

MODEL NUMBER	CAPACITY (POUNDS)	OVERALL FORK DIMENSIONS	SERVICE RANGE	BETWEEN FORKS
PM5-2748-PA	5,500	27"W x 48"L	2-7/8" - 7-3/4"	15"



Accumulator

MODEL:  
PM5-2748-PA



## Full Featured Deluxe Pallet Truck

The **Full Featured Ergonomic Pallet Truck** is an economical way for one person to move heavy pallet loads without the use of a fork truck. Proven ergonomic design has been tested for providing years of reliable usage. This pallet truck includes two articulating steering wheels and two front load rollers. Ergonomic design requires only 75 lbs. of pulling force when fully loaded. Steering wheels include bearing dust covers for added life. Nose wheels are located on the front edge of each fork to assist in clean pallet entrance and exit. Reinforced triple-formed steel forks provide twice the strength of standard single-formed forks. Equipped with internally mounted solid steel adjustable push rods. Spring loaded loop handle automatically returns to vertical position when not in use. Chrome-plated hydraulic pump piston for long seal life. Capacity is 5,500 lbs.



Solid Steel Push Rod

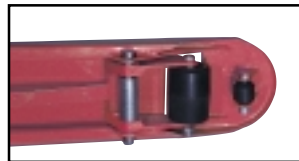

User Friendly Entry & Exit Wheels

MODEL NUMBER	CAPACITY (POUNDS)	OVERALL FORK DIMENSIONS	SERVICE RANGE	BETWEEN FORKS
PM5-2048	5,500	20"W x 48"L	2-7/8" - 7-3/4"	7"
PM5-2748	5,500	27"W x 48"L	2-7/8" - 7-3/4"	13"



Rubber Grip Handle

MODEL:  
PM5-2748

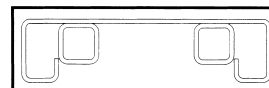

Triple-formed reinforced steel forks

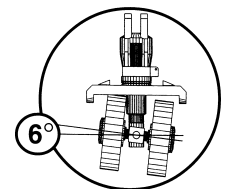

6°